

JUNE 2024

---



---

STORAGE COLLECTION  
**COLONNADE**  
SPECIFICATION GUIDE

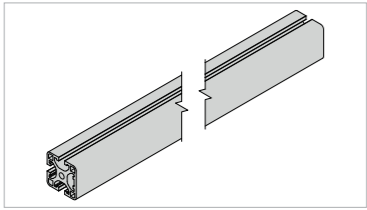
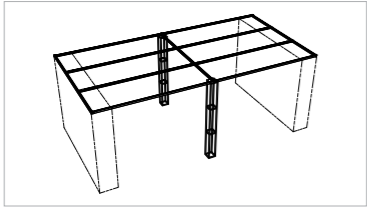
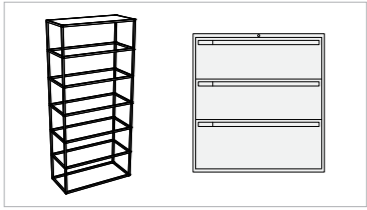
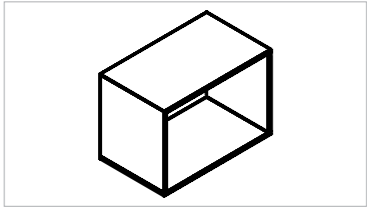
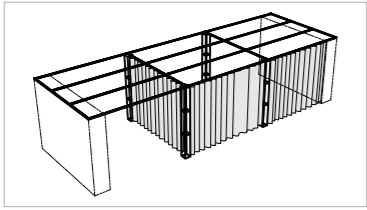
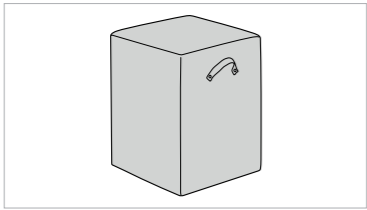

Page 3		Generic specification / systems in detail
Page 4-5		Colonnade Gantry Components
Page 6-7		Prefigured Colonnade Gentries
Page 8-9		Shelving Frames and Storage Units
Page 10-19		Accessories
Page 20		Curtains
Page 21		Seating
Page 22-23		Care & Maintenance

**Colonnade**

Colonnade was co-created in partnership with one of KI's longest-standing clients to create a systemised, cost-effective and sustainable solution to create better user-controlled, flexible workspaces. Made for 'hacking' - the system utilises a series of simple components and materials, in different dimensions. Accessories and features can be added and modified as required.

Anchored by 800 Series Storage and Modular Shelving, the stanchions and gantry system can support all sorts of equipment to make collaborative working better - from mobile whiteboards & pinboards, to TV screens, tables, mobile soft seating, power, lighting and acoustic treatments. This system can either be specified as an enhancement to existing KI storage, or be installed as new. Repurposing traditional storage units gives them a new lease of life, reducing waste and carbon footprint.

Please refer to <https://www.kieurope.com/colonnade/> for product finishes.

**Warranty Details**

Steel frames - 25 Years  
 Steel storage - 25 Years



**Indoor Advantage Gold - Furniture**

This product is certified to Indoor Advantage Gold - Furniture, making it suitable for many building rating systems, including LEED v4, BREEAM, & WELL Building.

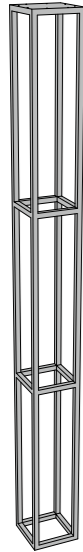

Colonnade Support Stanchion. 200mm x 200mm welded 20mm steel tube, 2180mm high.

**Product Code**

CLD/CLMN/2180	Support Stanchion
CLD/CLMN/CM/2180	Cable Managed Support Stanchion

Colonnade Gantry Rails, 40x40mm square section tube. Includes barrel end connectors and bolts. Prefigured sizes for 2, 3 & 4 800mm and 1000mm wide storage units.

**Top rail with 3 slots. Use on outer perimeter.**

Product Code	Size
CLD/1520/3S	1600 (actual 1520mm)
CLD/2320/3S	2400 (actual 2320mm)
CLD/3120/3S	3200 (actual 3120mm)
CLD/1920/3S	2000 (actual 1920mm)
CLD/2920/3S	3000 (actual 2920mm)
CLD/3920/3S	4000 (actual 3920mm)

**Top rail with 4 slots. Use on inside sections.**

Product Code	Size
CLD/1520/4S	1600 (actual 1520mm)
CLD/2320/4S	2400 (actual 2320mm)
CLD/3120/4S	3200 (actual 3120mm)
CLD/1920/4S	2000 (actual 1920mm)
CLD/2920/4S	3000 (actual 2920mm)
CLD/3920/4S	4000 (actual 3920mm)

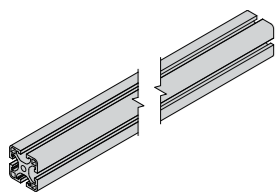
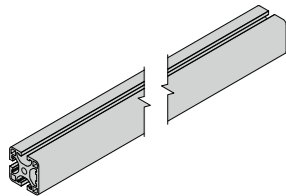

Rail Connector Cubes, 40x40x40mm.

**Product Code**

**Description**

CLD/40/CUBE/2S	2 way connector
CLD/40/CUBE/3S	3 way connector
CLD/40/CUBE/4S	4 way connector

CLD/ALUCAP Aluminium cube cap

CLD/RAIL/BKT Rail Connector Plate. Includes fixings.

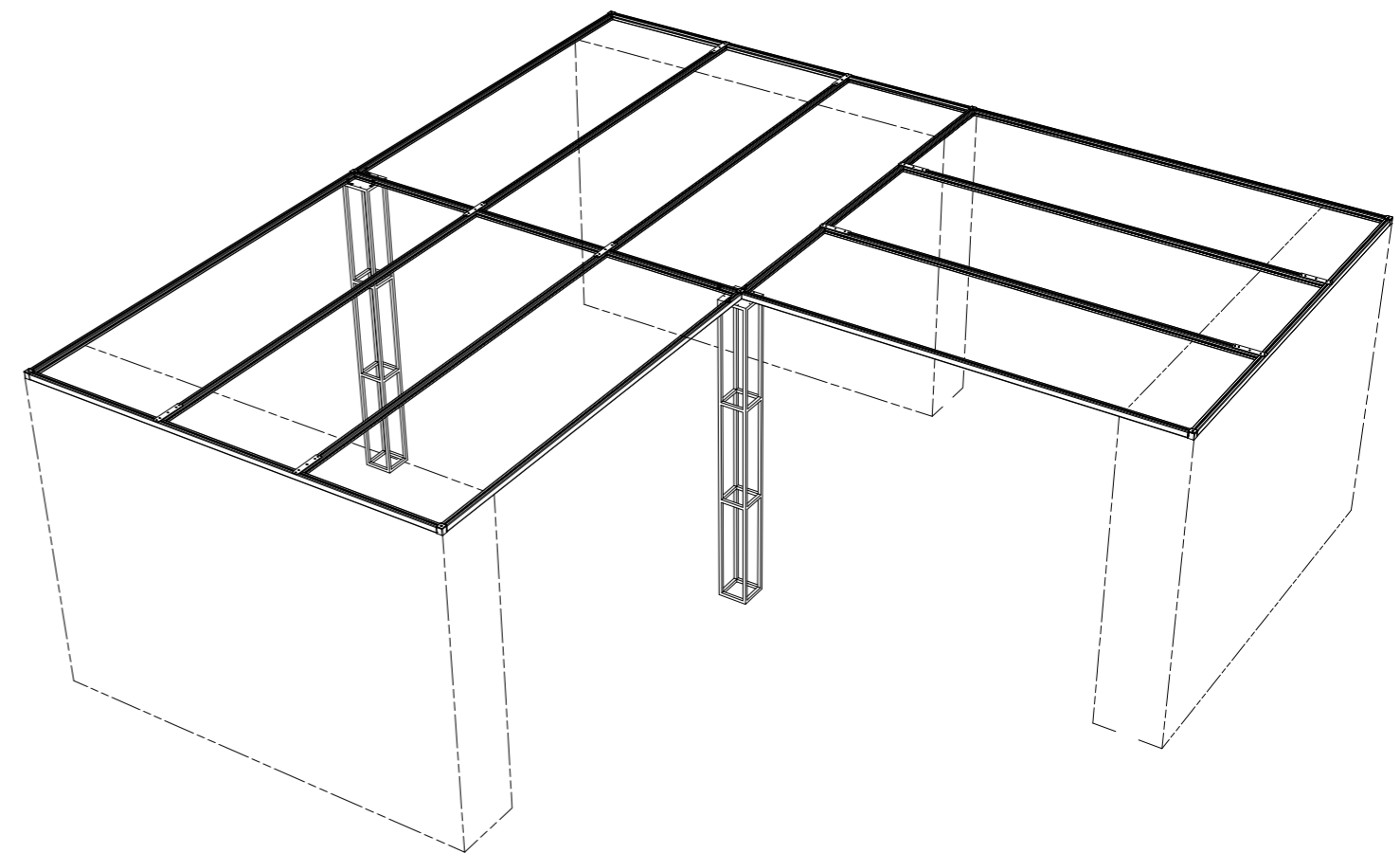
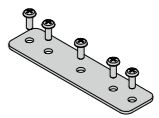
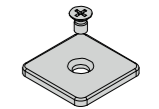
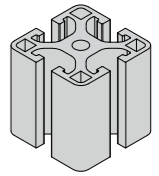

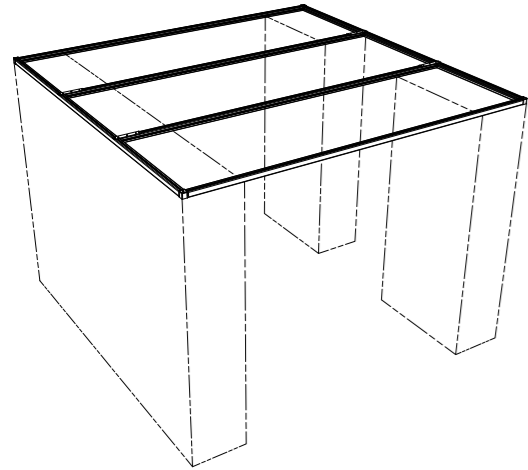

A selection of frequently specified sizes. For other configurations please contact your KI Sales Manager to discuss your requirements.

Product Code	Single Bay Gantry Size (A x B)
CLD/1B/2020	2000mm x 2000mm
CLD/1B/2424	2400mm x 2400mm
CLD/1B/3020	3000mm x 2000mm
CLD/1B/3030	3000mm x 3000mm
CLD/1B/3040	3000mm x 4000mm
CLD/1B/4040	4000mm x 4000mm

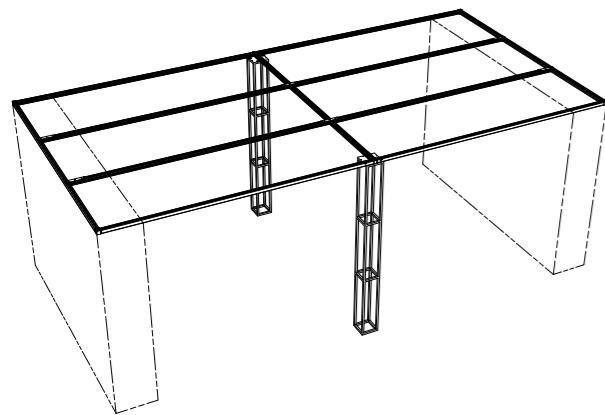

Product Code	Two Bay Gantry Size (A x B)
CLD/2B/2040	2000mm x 4000mm
CLD/2B/2060	2000mm x 6000mm
CLD/2B/2448	2400mm x 4800mm
CLD/2B/3048	3000mm x 4800mm
CLD/2B/3060	3000mm x 6000mm
CLD/2B/4080	4000mm x 8000mm

A selection of frequently specified sizes. For other configurations please contact your KI Sales Manager to discuss your requirements.

Product Code	Three Bay Gantry Size (A x B)
CLD/3B/2060	2000mm x 6000mm
CLD/3B/3072	3000mm x 7200mm
CLD/3B/3090	3000mm x 9000mm
CLD/3B/4090	4000mm x 9000mm
CLD/3B/40120	4000mm x 12000mm

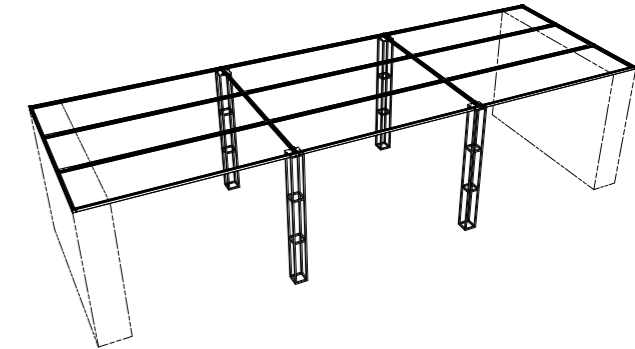

Product Code	'L' Shape Three Bay Gantry Size (A x B)
CLD/3BL/4040	4000mm x 4000mm
CLD/3BL/4848	4800mm x 4800mm
CLD/3BL/6060	6000mm x 6000mm
CLD/3BL/8080	8000mm x 8000mm

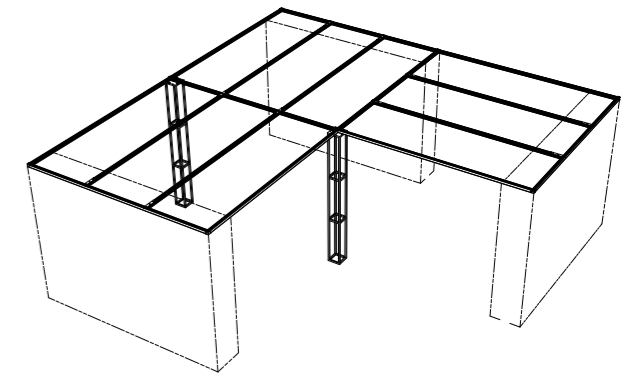

Prefigured 800 Series Shelving Units. 3 levels go on 1075mm high storage, 4 levels to go on 715mm high storage, 6 levels for floorstanding shelving and a 4 level unit with shelves for seating storage. Each unit includes one gantry connecting top shelf and ganging rails. Refer to the 800 Series Shelving Specification Guide for details of the complete range.

Description	Product Code	Width
3 High	8SH/A5/800/CLD	800mm
	8SH/A5/1000/CLD	1000mm
4 High	8SH/A7/800/CLD	800mm
	8SH/A7/1000/CLD	1000mm
6 High	8SH/A11/800/CLD	800mm
	8SH/A11/1000/CLD	1000mm
4 High Seating Storage (includes 4 standard steel shelves)	8SH/SEATING/457/CLD	457mm
	8SH/SEATING/800/CLD	800mm
	8SH/SEATING/1000/CLD	1000mm

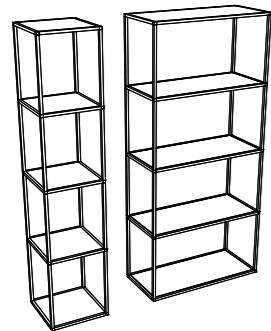
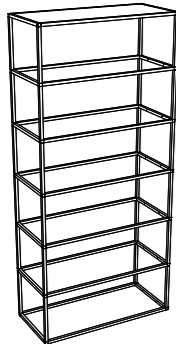
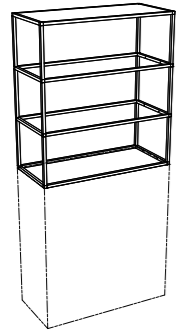

715mm & 1075mm high 800 Series Storage units. Refer to the 800 Series Specification Guide for details of the complete range.

715mm High		
Description	Product Code	Width
<b>2 Drawer</b> 2x 305mm drawers, 33mm blank top infill panel.	84ML/802552D	800mm
	84ML/1002552D	1000mm
Two door cupboard	8ML/80255HX	800mm
	8ML/100255HX	1000mm
1075mm High		
Description	Product Code	Width
<b>3 Drawer</b> 2x 305mm drawers, 1x 381mm bottom drawer.	84ML/803903D	800mm
	84ML/1003903D	1000mm
<b>3 Drawer</b> 1x 381mm receding door with slotted shelf. 2x 305mm drawers	84ML/803901F2D	800mm
	84ML/1003901F2D	1000mm
<b>6 Locker Doors</b> 2 wide by 3 high	8ML/804052X3L	800mm
	8ML/1004052X3L	1000mm
Two door cupboard	8ML/80390HX	800mm
	8ML/100390HX	1000mm
Two door TV cupboard with cable access in base and top	8ML/100390HX/CM	1000mm

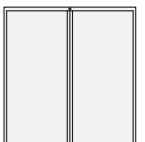
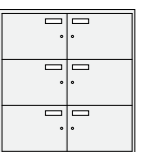
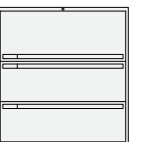
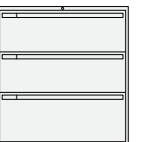
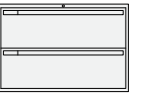

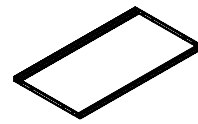

Steel Shelves - all fixings included	
Product Code	Width
8SH/SSH/08/756	800mm
8SH/SSH/10/956	1000mm
8SH/SSH/10/CM/956	1000mm cable managed

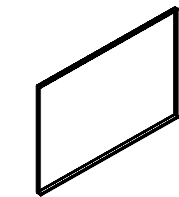

Steel Vertical Back Panels - all fixings included		
Product Code	Width	Height
8SH/BP/340/08/760	800mm	S (340mm)
8SH/BP/340/10/960	1000mm	S (340mm)
8SH/BP/520/08/760	800mm	M (520mm)
8SH/BP/520/10/960	1000mm	M (520mm)
8SH/BP/700/08/760	800mm	L (700mm)
8SH/BP/700/10/960	1000mm	L (700mm)

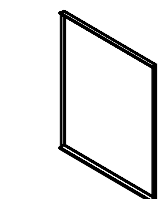

Perforated Steel Vertical Back Panels - all fixings included		
Product Code	Width	Height
8SH/PBP/340/08/760	800mm	S (340mm)
8SH/PBP/340/10/960	1000mm	S (340mm)

Steel Vertical Side Panels - all fixings included		
Product Code	Depth	Height
8SH/SP/340/417	457mm	S (340mm)
8SH/SP/520/417	457mm	M (520mm)
8SH/SP/700/417	457mm	L (700mm)

Perforated Steel Vertical Side Panels - all fixings included		
Product Code	Depth	Height
8SH/PSP/340/417	457mm	S (340mm)

MFC Shelves - require a set of shelf brackets each	
Product Code	Width
8SH/MSH/08/756	800mm
8SH/MSH/10/956	1000mm

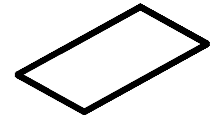

MFC Boxes - require a set of shelf brackets each		
Product Code	Width	Height
8SH/MFCBOX/759/339/457	800mm	S (340mm)
8SH/MFCBOX/959/339/457	1000mm	S (340mm)
8SH/MFCBOX/759/519/457	800mm	M (520mm)
8SH/MFCBOX/959/519/457	1000mm	M (520mm)
8SH/MFCBOX/759/699/457	800mm	L (700mm)
8SH/MFCBOX/959/699/457	1000mm	L (700mm)

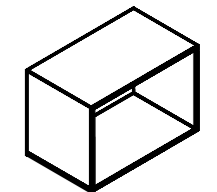

MFC Planters - require a set of shelf brackets each	
Product Code	Width
8SH/MFCPLAN/759/150/457	800mm
8SH/MFCPLAN/959/150/457	1000mm

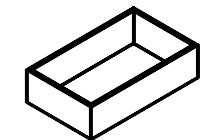

8SH/SH/BR Shelf brackets for MFC & Ply Insert (one set per insert)

MFC Vertical Front/ Back Panels - each panel requires 4No. MFC Vertical Brackets		
Product Code	Width	Height
8SH/MFCVP/340/08/758	800mm	S (340mm)
8SH/MFCVP/340/10/958	1000mm	S (340mm)
8SH/MFCVP/520/08/758	800mm	M (520mm)
8SH/MFCVP/520/10/958	1000mm	M (520mm)
8SH/MFCVP/700/08/758	800mm	L (700mm)
8SH/MFCVP/700/10/958	1000mm	L (700mm)

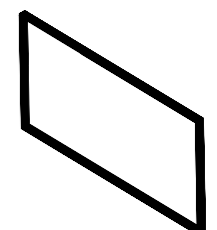

MFC Vertical Side Panels - each panel requires 2No. MFC Vertical Brackets		
Product Code	Depth	Height
8SH/MFCVP/340/04/415	457mm	S (340mm)
8SH/MFCVP/520/04/415	457mm	M (520mm)
8SH/MFCVP/700/04/415	457mm	L (700mm)

8SH/MFCVP/BKT MFC Vertical bracket

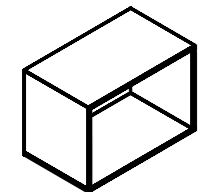
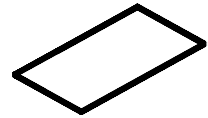

Ply Shelves - require a set of shelf brackets each		
Product Code	Width	
8SH/PSH/08/756	800mm	
8SH/PSH/10/956	1000mm	
Ply Boxes - require a set of shelf brackets each		
Product Code	Width	Height
8SH/PLYBOX/759/339/457	800mm	S (340mm)
8SH/PLYBOX/959/339/457	1000mm	S (340mm)
8SH/PLYBOX/759/519/457	800mm	M (520mm)
8SH/PLYBOX/959/519/457	1000mm	M (520mm)
8SH/PLYBOX/759/699/457	800mm	L (700mm)
8SH/PLYBOX/959/699/457	1000mm	L (700mm)

Product Code	Width	Height
CLD/PET/800-380	800mm	380mm
CLD/PET/800-560	800mm	560mm
CLD/PET/800-740	800mm	740mm
CLD/PET/800-2180	800mm	2180mm
CLD/PET/1000-380	1000mm	380mm
CLD/PET/1000-560	1000mm	560mm
CLD/PET/1000-740	1000mm	740mm
CLD/PET/1000-2180	1000mm	2180mm

## Rectangular module steel door & drawer inserts

Touch latch cupboard doors with side, back and base panels. For perforations add /P to the code, upcharge of £66.		
Product Code	Width	Height
8SH/2DR/INSERT/800/340	800mm	S (340mm)
8SH/2DR/INSERT/1000/340	1000mm	S (340mm)
8SH/2DR/INSERT/800/520	800mm	M (520mm)
8SH/2DR/INSERT/1000/520	1000mm	M (520mm)
Locker doors with standard key lock. Includes central divider, side, back, and base panels. For perforations add /P to the code, upcharge of £66.		
Product Code	Width	Height
8SH/2DRL/INSERT/800/520	800mm	M (520mm)
8SH/2DRL/INSERT/1000/520	1000mm	M (520mm)
8SH/1DRL/INSERT/457/520	457mm (single door)	M (520mm)
Touch latch drawers doors with side, back and base panels.		
Product Code	Width	Height
8SH/DRW/INSERT/800/340	800mm	S (340mm)
8SH/DRW/INSERT/1000/340	1000mm	S (340mm)

# Moss panels

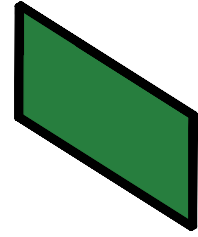

Preserved Moss Panels		
Product Code	Width	Height
8SH/MOSSPANEL/720/300	800mm	S (340mm)
8SH/MOSSPANEL/920/300	1000mm	S (340mm)
8SH/MOSSPANEL/720/480	800mm	M (520mm)
8SH/MOSSPANEL/920/480	1000mm	M (520mm)
8SH/MOSSPANEL/720/660	800mm	L (700mm)
8SH/MOSSPANEL/920/660	1000mm	L (700mm)

# Planters & liners

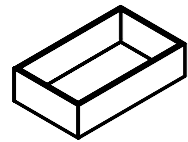

Ply Planters - require a set of shelf brackets each		
Product Code	Width	
8SH/PLYPLANT/759/150/457	800mm	
8SH/PLYPLANT/959/150/457	1000mm	
MFC Planters - require a set of shelf brackets each		
Product Code	Width	
8SH/MFCPLAN/759/150/457	800mm	
8SH/MFCPLAN/959/150/457	1000mm	
8SH/SH/BR	Shelf brackets for MFC & Ply Insert (one set per insert)	
Waterproof Planter Liners - 100% recycled ABS, Black finish. <u>MINIMUM 10 ORDER QTY</u>		
Product Code	Width	List Price (£)
8SH/80LINER	800mm	
8SH/100LINER	1000mm	

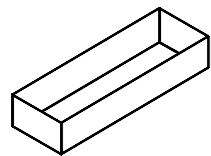

# Moss panel boxes

MFC Moss Panel Display Boxes - require a set of shelf brackets each		
Product Code	Width	Height
8SH/MFCMOSS/759/339/457	800mm	S (340mm)
8SH/MFCMOSS/959/339/457	1000mm	S (340mm)
8SH/MFCMOSS/759/519/457	800mm	M (520mm)
8SH/MFCMOSS/959/519/457	1000mm	M (520mm)
8SH/MFCMOSS/759/699/457	800mm	L (700mm)
8SH/MFCMOSS/959/699/457	1000mm	L (700mm)

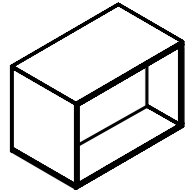

Ply Moss Panel Display Boxes - require a set of shelf brackets each		
Product Code	Width	Height
8SH/PLYMOSS/759/339/457	800mm	S (340mm)
8SH/PLYMOSS/959/339/457	1000mm	S (340mm)
8SH/PLYMOSS/759/519/457	800mm	M (520mm)
8SH/PLYMOSS/959/519/457	1000mm	M (520mm)
8SH/PLYMOSS/759/699/457	800mm	L (700mm)
8SH/PLYMOSS/959/699/457	1000mm	L (700mm)

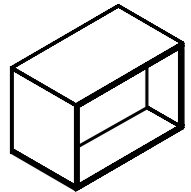

8SH/SH/BR Shelf brackets for MFC & Ply Insert (one set per insert)



Touch latch cupboard doors with side, back and base panels.  
For perforations add /P to the code.

Product Code	Width	Height
8SH/2DR/INSERT/800/340	800mm	S (340mm)
8SH/2DR/INSERT/1000/340	1000mm	S (340mm)
8SH/2DR/INSERT/800/520	800mm	M (520mm)
8SH/2DR/INSERT/1000/520	1000mm	M (520mm)

Locker doors with standard key lock. Includes central divider, side, back, and base panels.  
For perforations add /P to the code, upcharge of £66.

Product Code	Width	Height
8SH/2DRL/INSERT/800/520	800mm	M (520mm)
8SH/2DRL/INSERT/1000/520	1000mm	M (520mm)
8SH/1DRL/INSERT/457/520	457mm (single door)	M (520mm)

Touch latch drawers doors with side, back and base panels.

Product Code	Width	Height
8SH/DRW/INSERT/800/340	800mm	S (340mm)
8SH/DRW/INSERT/1000/340	1000mm	S (340mm)

Product Code	Description
8SH/TABLE/457-457	457mm x 457mm x 380mm high side table
8SH/TABLE/800-457	800mm x 457mm x 380mm high side table
8SH/TABLE/1000-457	1000mm x 457mm x 380mm high side table
8SH/TABLE/800-800	800mm x 800mm x 380mm high side table
8SH/TABLE/800-1000	800mm x 1000mm x 380mm high side table
8SH/TABLE/1000-1000	1000mm x 1000mm x 380mm high side table

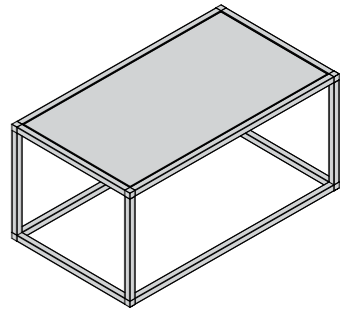

Product Code	Description
8SH/SEAT/800	800mm x 457mm x 460mm high seat
8SH/SEAT/1000	1000mm x 457mm x 460mm high seat

**Fabric Options: Camira Xtreme**

\*Other fabrics available, subject to suitability. Customer's own materials (COM) also available, please confirm with your KI account manager.

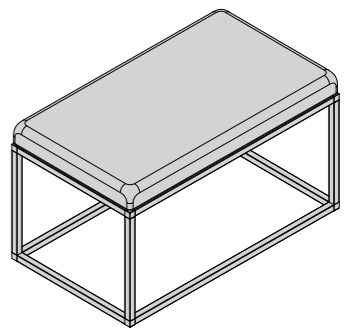

WHITEBOARD MINIMUM ORDER QUANTITY 5

Product Code	Description
--------------	-------------

CLD/EASEL	Whiteboard easel
-----------	------------------



CLD/2G/POWER	Support stanchion 2 Gang power
--------------	--------------------------------

CLD/4G/POWER	Support stanchion 4 Gang power
--------------	--------------------------------

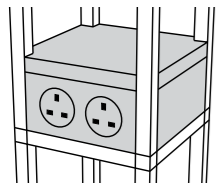

CLD/2525138	Coiled Starter Cable, 800mm up to 1.5m. Female GST Wieland to UK plug.
-------------	------------------------------------------------------------------------



CLD/STORAGE-POT	Colonnade stanchion steel storage pot
-----------------	---------------------------------------

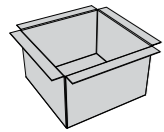

CLD/STANCHION-SHELF	Colonnade stanchion ply shelf
---------------------	-------------------------------

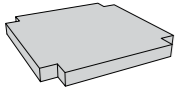

PET Ceiling Grids must be ordered in pairs

Product Code	Description
--------------	-------------

CLD/PET/GRID/800	PET Large Ceiling Grid for 800mm wide spans
------------------	---------------------------------------------

CLD/PET/GRID/1000	PET Large Ceiling Grid for 1000mm wide spans
-------------------	----------------------------------------------

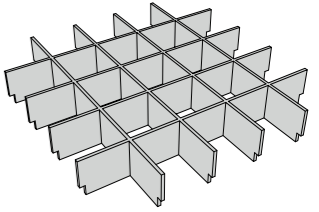

C Series Floor Standing Screens - 800mm Wide. Select base and screen panel. Blazer Lite Fabric, refer to [www.kieurope.com](http://www.kieurope.com) for fabric colours.

Product Code	Description
--------------	-------------

C/FS/BP/STAT	C Series Freestanding Screen Base
--------------	-----------------------------------

C/FS/T1/0815	1500mm high screen panel
--------------	--------------------------

C/FS/T1/0818	1800mm high screen panel
--------------	--------------------------

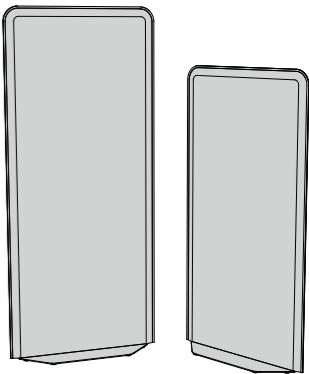

Divider Curtain with rail and low friction runners. Available in three Fabric Bands. Add /A etc to the code.  
 Band A - Edmund Bell Manhattan  
 Band B - Kvadrat Daybreak  
 Band C - Kvadrat Drops Acoustic  
 Refer to [www.kieurope.com](http://www.kieurope.com) for fabric colours.

For bespoke fabric choices please refer to your KI Sales Manager.

Product Code	Nominal Bay Width
CLD/CURT/2M	2000mm
CLD/CURT/3M	3000mm
CLD/CURT/4M	4000mm

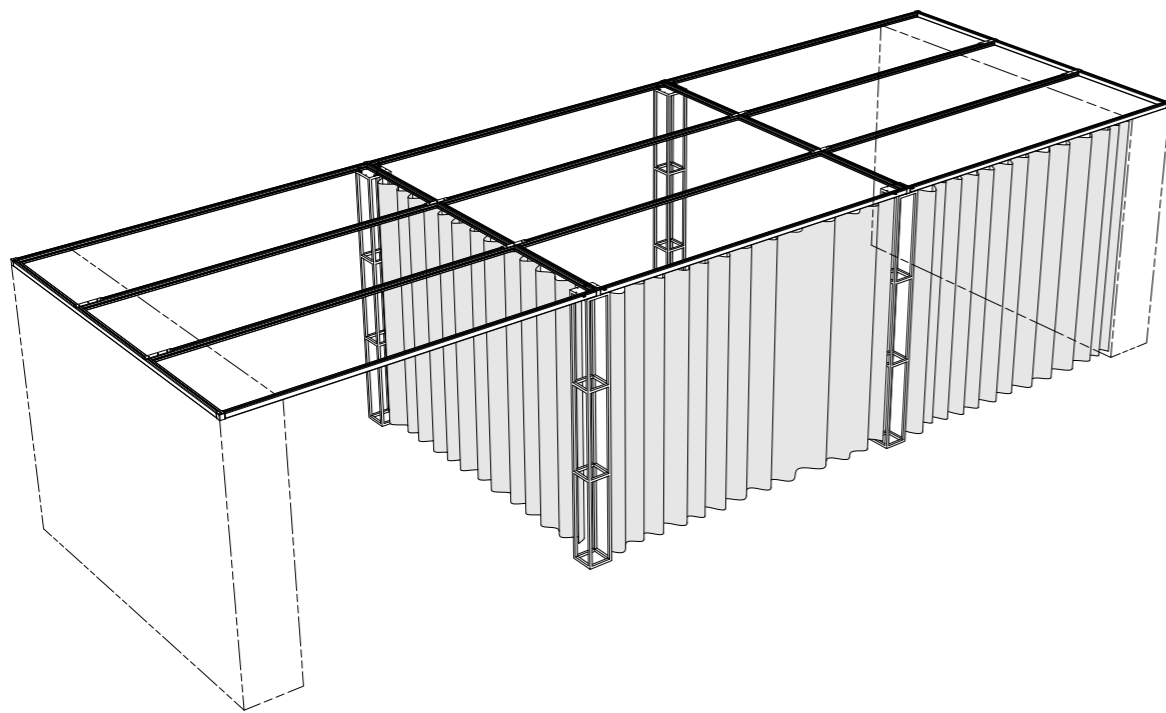

Cube Seat with handle. 400mm x 400mm x 480mm high. Available in five Fabric Bands.  
 Band A - Camira Patina  
 Band B - Camira Mainline Flax  
 Band C - Camira Blazer  
 Band D - Svensson Velvet Pocket & Accessoire Kajal  
 Band E - Kvadrat Rime

Refer to [www.kieurope.com](http://www.kieurope.com) for fabric colours.

Product Code
CLD/SEATCUBE/A
CLD/SEATCUBE/B
CLD/SEATCUBE/C
CLD/SEATCUBE/D
CLD/SEATCUBE/E

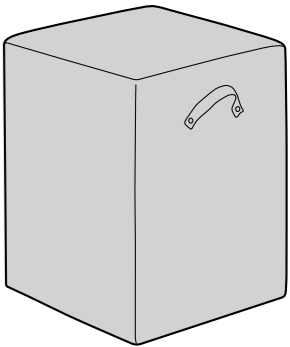

Ricochet Seat. An active seat with 12 degrees of movement. Refer to [www.kieurope.com](http://www.kieurope.com) for colours.

Product Code	Fabric Band
RC410/H450	Ricochet Stool, 450mm high
RC410/H500	Ricochet Stool, 500mm high

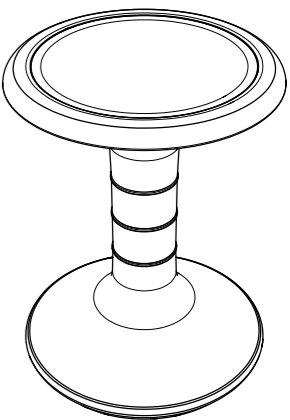

KI products are designed and manufactured to withstand the tough demands of work environments. Care and regular light cleaning will keep the furniture looking its best for many years.

## IMPORTANT CARE & SAFETY INFORMATION

- Melamine/MFMDf and other decorative worksurfaces will naturally wear over time resulting in shiny patches, particularly parts that are regularly used for mouse control and where the worksurface comes into contact with clothes, skin etc.
- **Always use mouse mats to minimise the long-term effects of continuous contact and movement within the same area of the top.**
- Once the workstations/tables have been assembled, sited and wired they should not be moved
- Never attempt to drag them across the floor, which will stress and strain the end legs
- Avoid placing your furniture in direct sunlight, as sunlight causes fading
- Mats and coasters must be used as they offer the best protection from scratches, hot liquid and water marks
- Heavy office equipment such as printers should be placed on protective pads to avoid scratches to the worksurface
- Never drag heavy equipment across a worktop as this will damage the worksurface
- Do not immerse any part of the workstations/tables in water or any liquid
- Check all cords (power, control keypad, etc.) every 6 months to make sure there are no kinked, pinched or frayed wires



Should any items of furniture require repair, please contact KI (UK) Ltd for further information.

The guide below is intended to help where furniture has become marked or stained. Please check for colour fading in a discreet area when using any detergents or chemicals. Always follow the manufacturer of the cleaning products' instructions before use.

## GENERAL CARE

Proper care and careful use are the best methods of maintaining the appearance and finish of any product. Any desk or table worksurface is vulnerable to scratching and damage.

Your workstations/tables metal understructure is finished with durable powder-coated paint. Worktops are generally Melamine Faced Chipboard (MFC) or Melamine Faced Medium Density Fibreboard (MFMDf) (laminated).

Other worktop finishes e.g. Lino or Fenix NTM® should be cleaned according to the manufacturer's instructions.

Apart from regular cleaning, KI workstations are considered to be maintenance free however the following should be observed during a bench's lifetime:

## FRAMEWORK

- Where cleaning of the frame is required, a mild detergent solution should be used
- Harsh abrasives, acids, alkalis or bleaching products should not be used
- Touch-up paint in all standard KI colours is available to repair minor chips and scratches. Follow the instructions on the packaging to ensure the best results.

## MFC/ MFMDf WORKTOPS

- Melamine faced worksurfaces will naturally wear over time, particularly parts that are regularly rubbed. Utilizing a mouse mat will protect against this natural wear and tear.
- Work tops are easy to maintain, simply use a damp cloth and a mild detergent or non-abrasive cleaner to keep the surface clean and hygienic
- Potential stains should be removed immediately (the use of abrasive cleaners should always be avoided)
- Use an all-purpose cleaner to remove ink stains, crayon and water-based paint marks
- Use thinners to remove oil-based paint stains (pour onto a soft cloth, not directly on the surface) - avoid contact with the worktop edging, as this will cause damage
- Never use excessive water to clean work surfaces. Wetness or excessive moisture can cause laminate worktops to swell, warp or appear to grow in thickness



## STORAGE COLLECTION COLONNADE

KI (UK) Ltd  
New Fetter Place  
8-10 New Fetter Lane  
London, EC4A 1AZ  
Tel: +44 (0)20 7404 7441  
workplace@kieurope.com  
www.kieurope.com

*KI and Furnishing Knowledge are registered  
trademarks of Krueger International Inc*

